

# Export Controls, Human Rights, and Networked Technologies

---

Collin Anderson (@CDA)

# A Brief History of Surveillance Export Policy

Bhatt Murphy Solicitors  
DX 36626  
Finsbury

DX 123242 Kingsway 6  
Switchboard: 0207 210 3000  
Direct Line: 0207 210 4711  
Direct Fax: 020 7210 3001  
francesca.debenham@tsol.gsi.gov.uk

**AND BY EMAIL: m.scott@bhattmurphy.co.uk**

Please Quote: Z1211844/FZD/B5  
Your Reference: MPS/FT/002295/0001

8 August 2012

Dear Sirs

**EXPORT CONTROLS FOR SURVEILLANCE EQUIPMENT - PROPOSED JR**

1. We refer to your letter before claim under the pre-action protocol for judicial review dated 12 July 2012 ("**the PAP Letter**"). This is the response to that letter of the Secretary of State for Business Innovation and Skills ("**the Secretary of State**"). Please address any future correspondence in this matter to Francesca Debenham quoting the reference above.

FinFisher and Bahrain

Surveillance Export Policy







# Qosmos Partnership Model

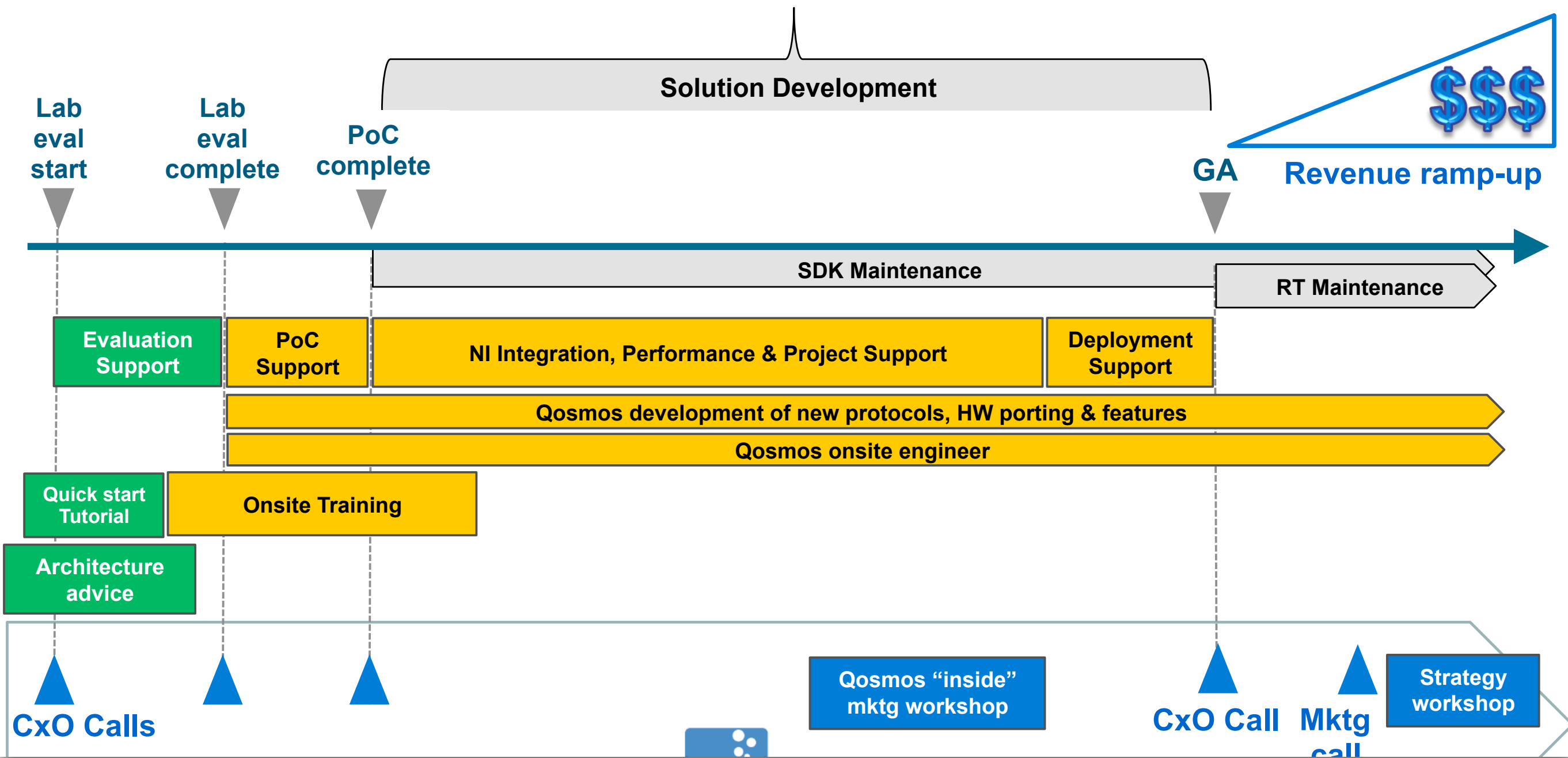

Area SpA and Syria

Surveillance Export Policy

# Growing Market

Snowden Disclosure, Concerns over “Going Dark” Fuel Industry

**TeleStrategies®**

# ISS World<sup>®</sup> America

**Intelligence Support Systems for Lawful Interception,  
NSA Data Retention, Cyber Threat Detection and Information SH**

**SEPTEMBER 29 – OCTOBER 1, 2015 • WASHINGTON DC**

**CyberThreat Detection**

**Offensive IT Intrusion**

**Investigating Bitcoin Blockchain**

**Where Law Enforcement, Public Safety, Telecoms and the Intelligence Community turn for Technical Training and Product Selection**

**Social Network Monitoring**

**Dark Web/TOR Traceback**

**Lead Sponsor**

**SS8**

**Associate Lead Sponsors**

**AQSACOM** **AREA** **FIRERLAZE** **]HackingTeam[**

**Exhibitors and Sponsors**

**MYRICOM** **FINFISHER** **Geofeedia** **Glimmerglass** **NetQuest** **octasic** **S.E.**

**To Review Complete Agenda or To Register, Go To [WWW.ISSWORLDTRAINING.COM](http://WWW.ISSWORLDTRAINING.COM)**

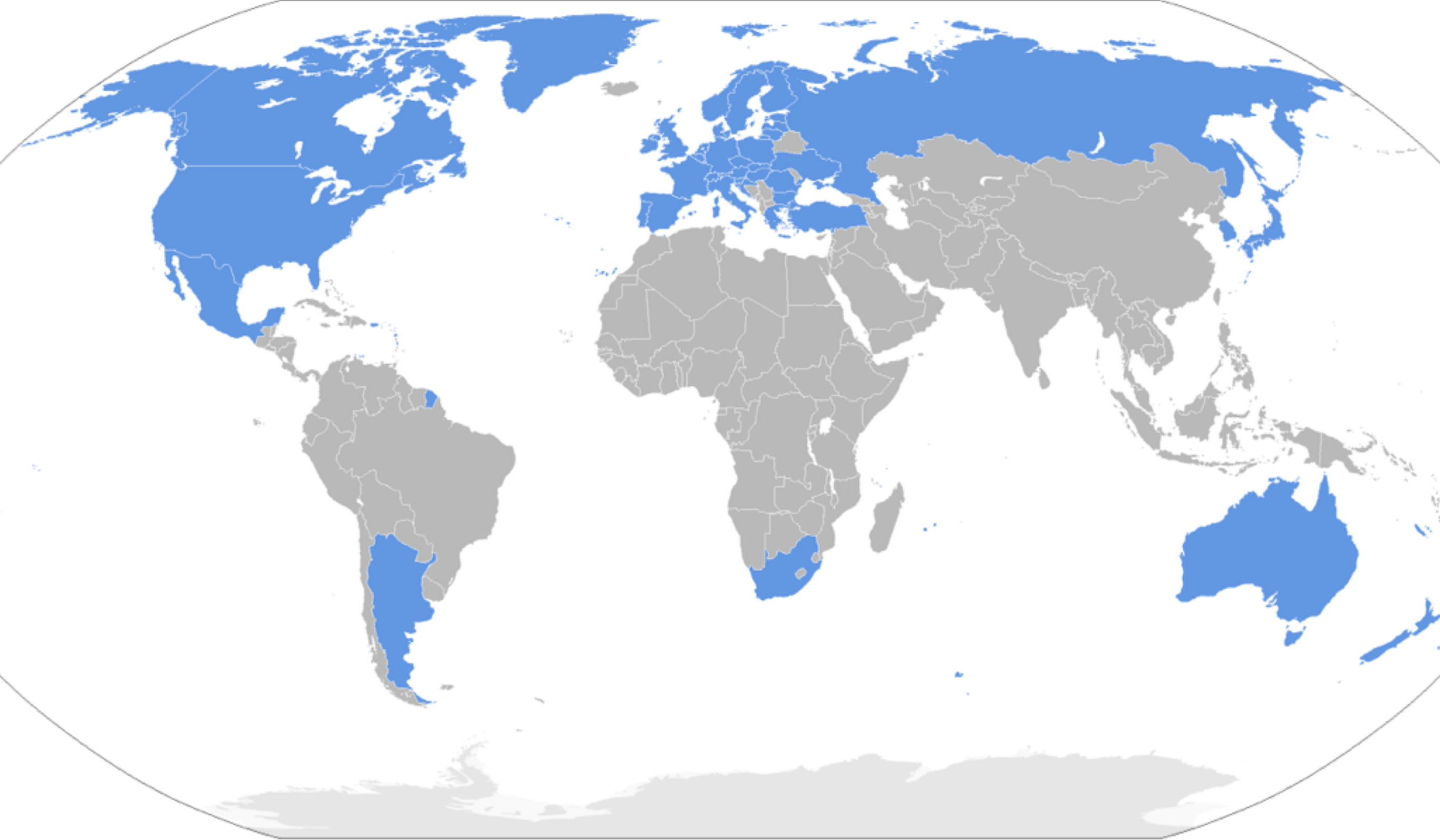

Wassenaar Arrangement

Export Control Regimes





a.8. Communications equipment designed or modified for surreptitious intrusion;

*Note: 5A002.a.8 applies to layer security.*

Communications Technologies Export Controls are Commonplace

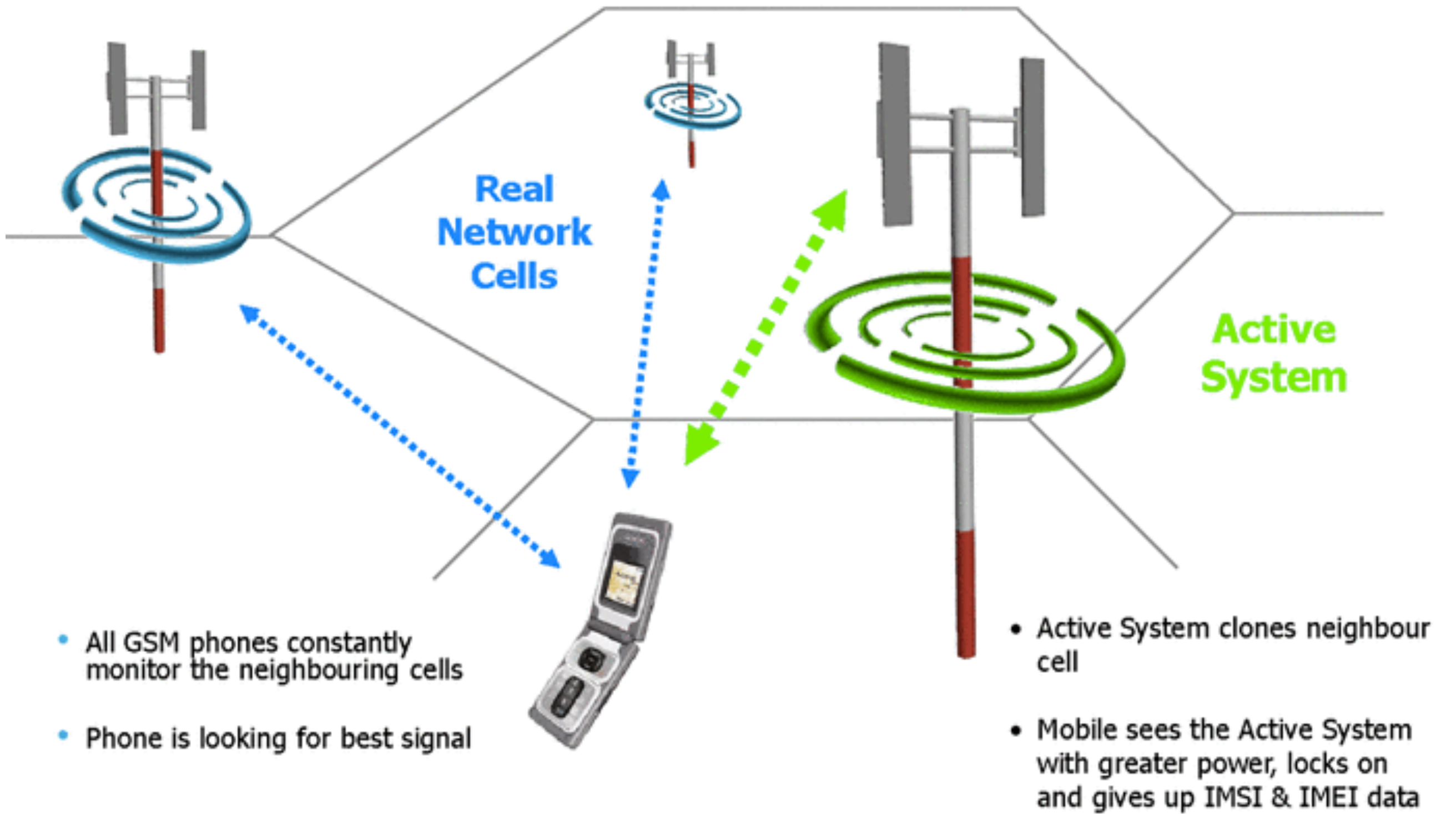

# IMSI Catchers/Cell Site Simulators

# Intrusion Software

## Controls

- Systems and software for the generation, operation or delivery of, or communication with Intrusion Software.
- Technology for the development of Intrusion Software.

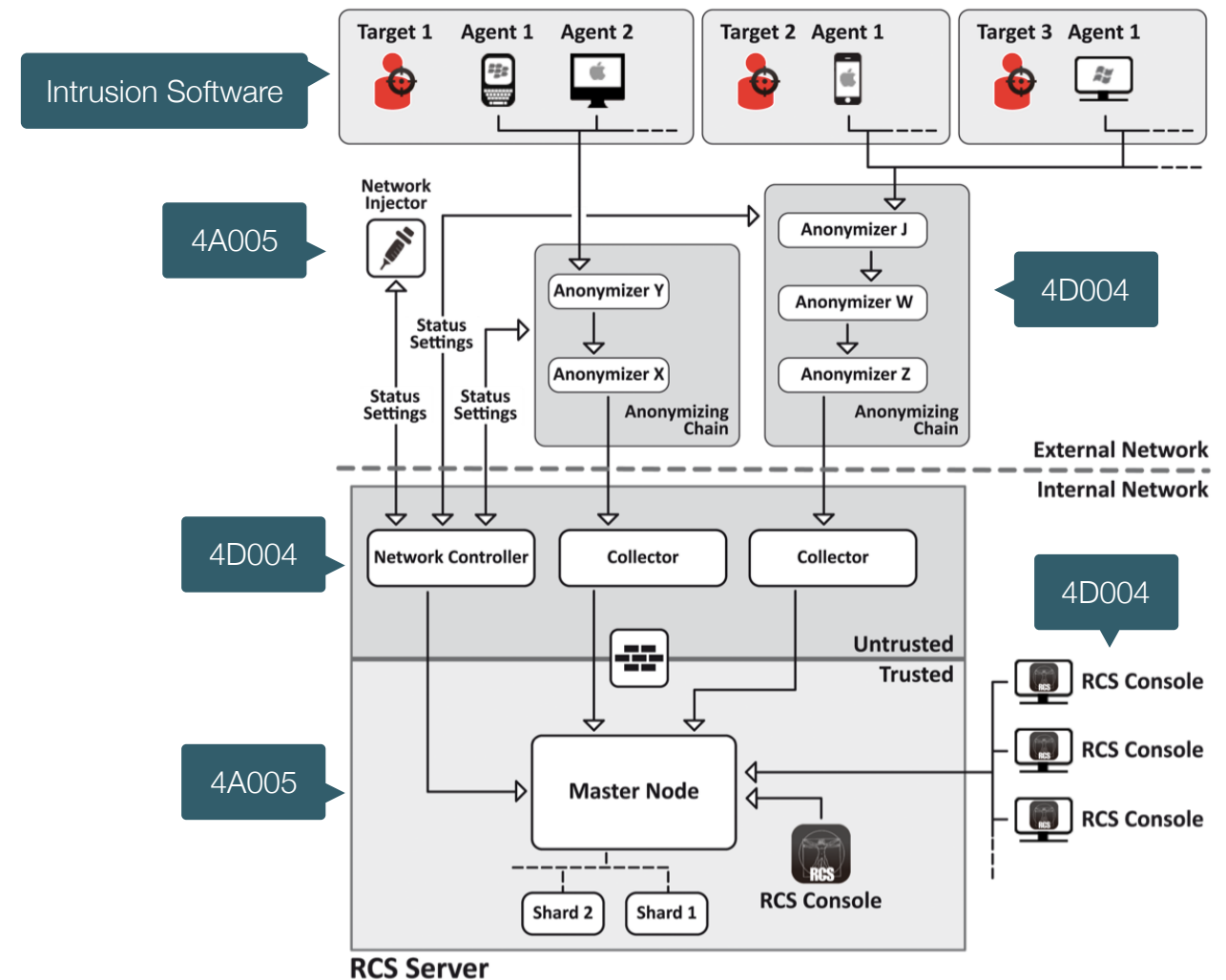



# IP Network Surveillance

- IP network communications surveillance systems having all of the following:
  - Performing all of the following on a carrier class IP network (e.g., national grade IP backbone):
    - Analysis at the application layer (e.g., Layer 7 of Open Systems Interconnection (OSI) model);
    - Extraction of selected metadata and application content;
    - Indexing of extracted data; and
- Being “specially designed” to carry out all of the following:
  - Execution of searches on the basis of ‘hard selectors’; and
  - Mapping of the relational network of an individual or of a group of people.

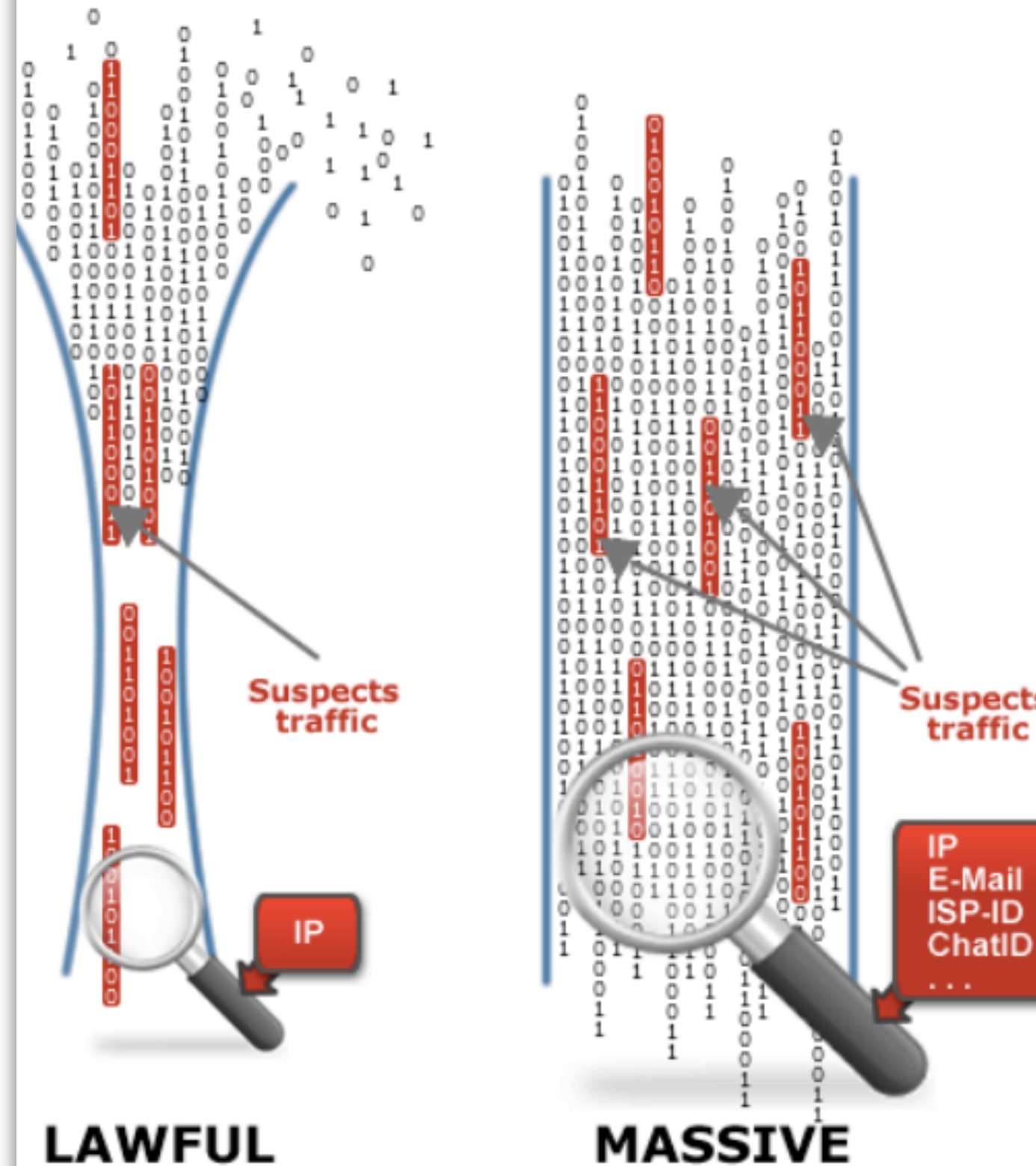

## Wassenaar Arrangement 2013 Plenary Agreements Implementation: Intrusion and Surveillance Items

[Docket Browser](#) [Return to Docket Folder Summary](#)

**Docket ID:** BIS-2015-0011    **Agency:** Bureau of Industry and Security (BIS)    **Parent Agency:** Department of Commerce (DOC)

### Summary:

The Bureau of Industry and Security (BIS) proposes to implement the agreements by the Wassenaar Arrangement (WA) at the Plenary meeting in December 2013 with regard to systems, equipment or components specially designed for the generation, operation or delivery of, or communication with, intrusion software; software specially designed or modified for the development or production of such systems, equipment or components; software specially designed for the generation, operation or delivery of, or communication with, intrusion software; technology required for the development of intrusion software; Internet Protocol (IP) network communications surveillance systems or equipment and test, inspection, production equipment, specially designed components thereof, and development ar... [more...](#)

**RIN:** 0694-AG49    **Impacts and Effects:** International    **CFR Citation:** 15 CFR 774,15 CFR 740,15 CFR 742,15 CFR 748,15 CFR 772    **Priority:** Other Significant

New Search within this Docket  Search Within Results

[Export](#) | [Sign-up for Email alert](#)

### Filter Results By...

264 results

#### Document Type

[Clear Filter](#)

- Notice (0)
- Proposed Rule (1)
- Rule (0)
- Supporting & Related Material (2)
- Other (0)
- Public Submission

#### Posted

#### Comments Due

Results per page: 25

Sort By: Best Match

#### Comment on FR Doc # 2015-11642

Comment on FR Doc # 2015-11642 The proposed Wassenaar Arrangement (WA) is hazardous to not only companies who intend to protect the public and private companies, but also to...

**Public Submission** | **Posted:** 07/27/2015 | **ID:** BIS-2015-0011-0123

**Submitter Name:** Jonathan Walker

[Comment Period Closed](#)

Jul 20, 2015 11:59 PM ET

#### Comment on FR Doc # 2015-11642

I work in the computer security industry, and have done so for 10 years of my life. This industry is a force for good, we study and evaluate computer security problems and attempt...

**Public Submission** | **Posted:** 07/27/2015 | **ID:** BIS-2015-0011-0203

**Organization:** self | **Submitter Name:** Michael Toecker

[Comment Period Closed](#)

Jul 20, 2015 11:59 PM ET

#### Comment on FR Doc # 2015-11642

The proposed rules will actually make us less secure by restricting those who are doing the most to secure our information.

[Comment Period Closed](#)

# Intrusion Software Control Has Been Controversial

## Wassenaar Arrangement

## PI Surveillance Industry Index

415 companies  
1911 individual brochures  
206 with HQ in EU MSs

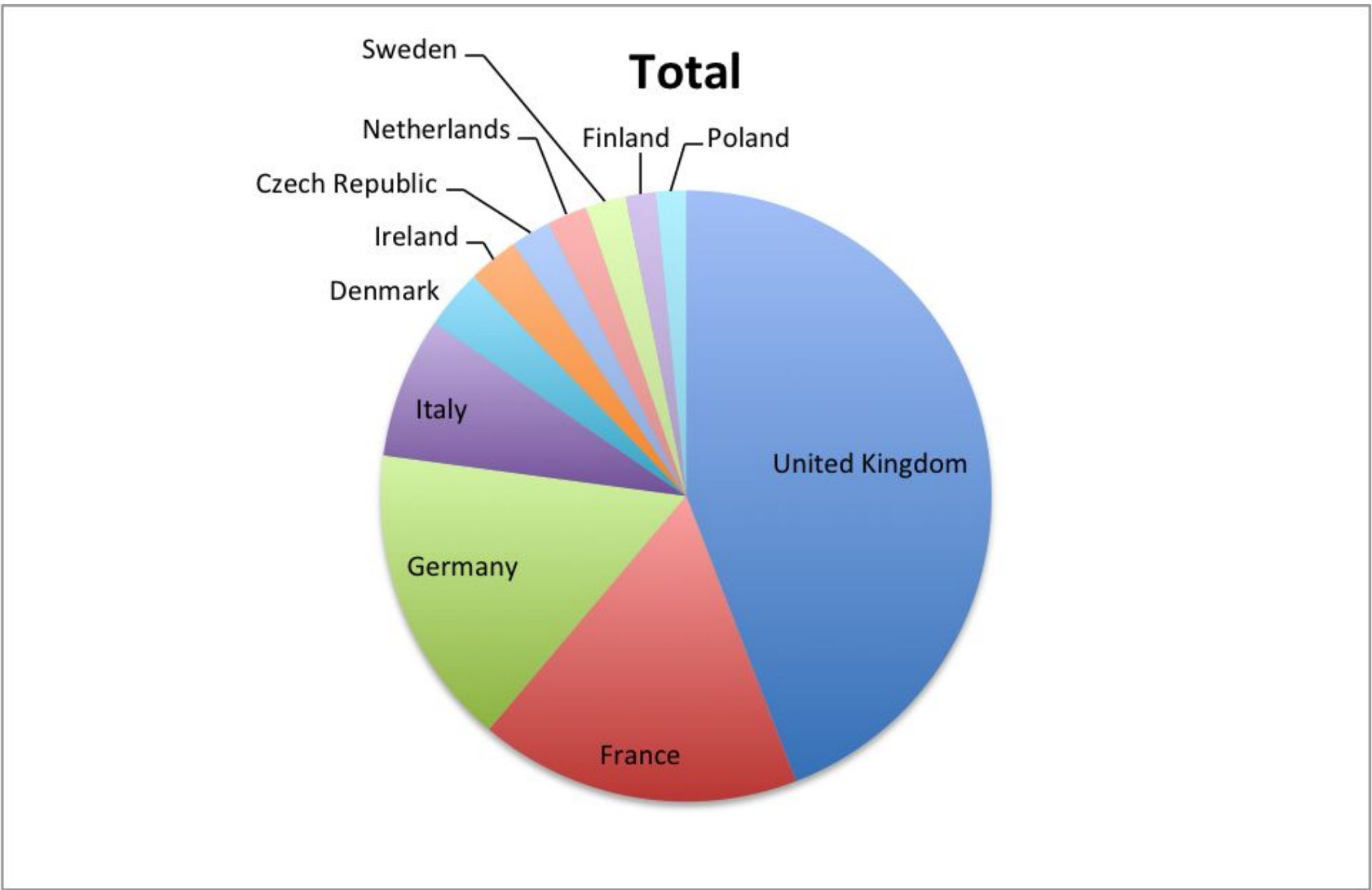

Europe Moves Forward

Unilateral and E.U. Controls



# German Unilateral Controls (5A902)

## Controls:

- Monitoring Centers for Lawful Interception Systems
- Data Retention Systems for Lawful Interception Information

## Does Not Cover:

- Billing, Quality of Service, Data Collection Functions with Routing
- Operation of Such Systems within Telecommunications Companies

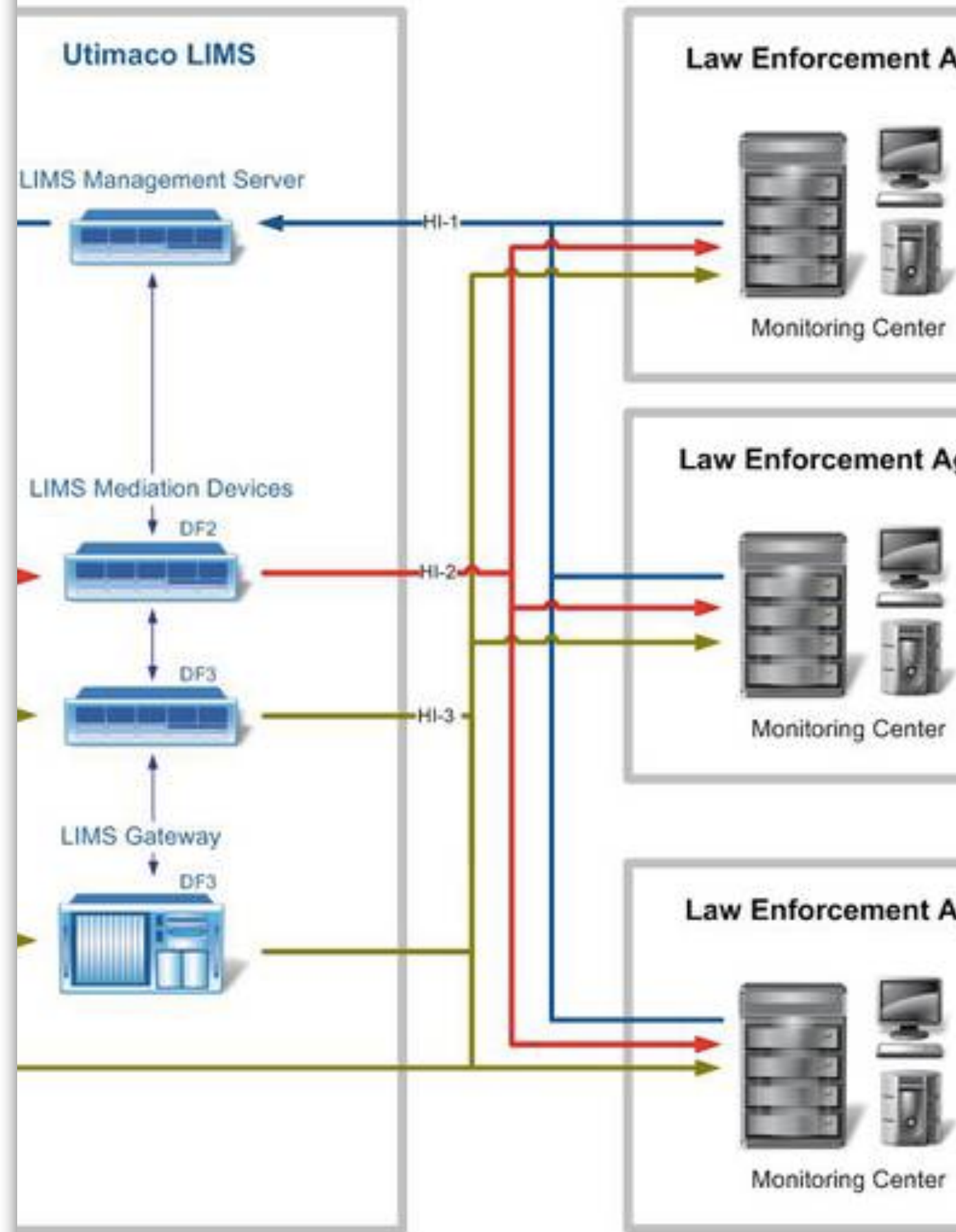

# Catch-all Controls

---

## Netherland's Encryption Controls

*'This license may not be used if the exporter is aware or has been informed by the competent authorities of the Member State where he is established, that the items in question are or may be intended... for use in connection with violations of human rights, the democratic principles, or the freedom of speech as described in the Charter of Fundamental Rights of the European Union, where use is made of interception techniques and digital data transfer equipment for the monitoring of cellular telephones and the reading of text messages and for the specific surveillance of internet use (for example by means of control centers and legal interception gateways).'*





# Human Security

---

## Human Rights as License Consideration Criteria.

Swiss authorities must reject companies' requests to export internet and mobile surveillance technologies if there "are reasonable grounds to believe" that the items could be used for repression in the country of destination.





**COUNCIL REGULATION (EC) No 428/2009**

**of 5 May 2009**

**setting up a Community regime for the control of exports, transfer, brokering and transit of dual-use items**

**(Recast)**

THE COUNCIL OF THE EUROPEAN UNION,

Having regard to the Treaty establishing the European Community, and in particular Article 133 thereof,

Having regard to the proposal from the Commission,

Whereas:

(1) Council Regulation (EC) No 1334/2000 of 22 June 2000 setting up a Community regime for the control of exports of dual-use items and technology <sup>(1)</sup> has been significantly amended on several occasions. Since further amendments are to be made, it should be recast in the interests of clarity

(5) The responsibility for deciding on individual, global or national general export authorisations, on authorisations for brokering services, on transits of non-Community dual-use items or on authorisations for the transfer within the Community of the dual-use items listed in Annex IV lies with national authorities. National provisions and decisions affecting exports of dual-use items must be taken in the framework of the common commercial policy, and in particular Council Regulation (EEC) No 2603/69 of 20 December 1969 establishing common rules for exports <sup>(2)</sup>.

(6) Decisions to update the common list of dual-use items subject to export controls must be in conformity with the obligations and commitments that Member States have accepted as members of the relevant international non-proliferation regimes and export control arrangements, or

European Union Export  
Reform Process

Export Control Regimes

Questions?

**Collin Anderson (@CDA)**